

## SL TeamConnect Accessories

MEB 102-L TC  
MEB 104-L TC  
MEB 114-S TC  
MAS 1 TC  
MAS 2 TC  
SL MIC HUB 1

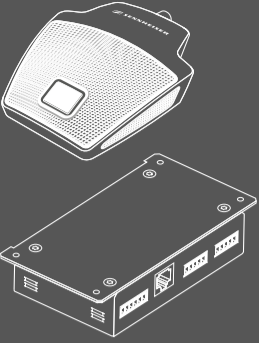

Quick Guide  
Kurzanleitung  
Guide rapide  
Guida rapida  
Instrucciones resumidas

Векторте handleiding  
Краткая инструкция  
快速指南  
クイックガイド  
퀵 가이드

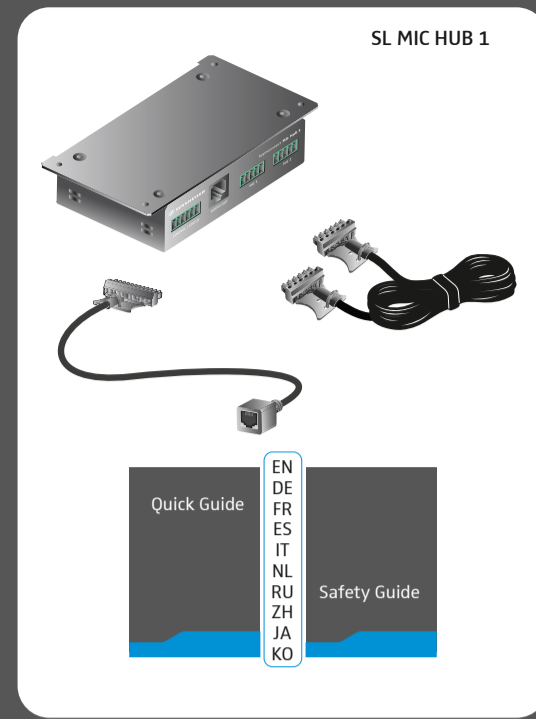
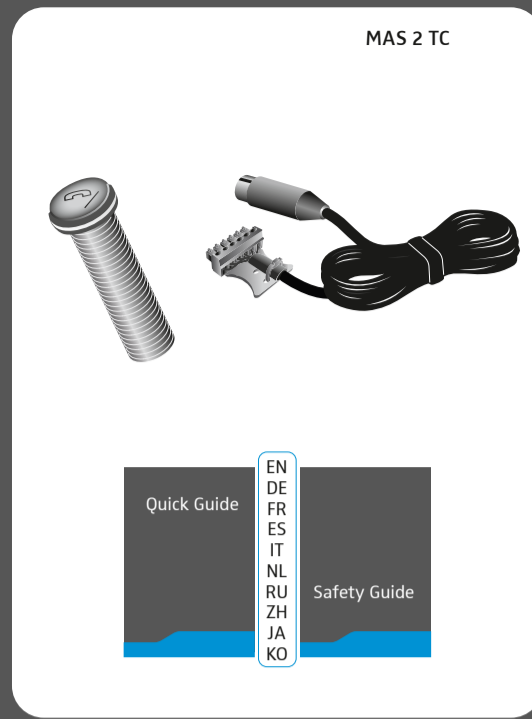
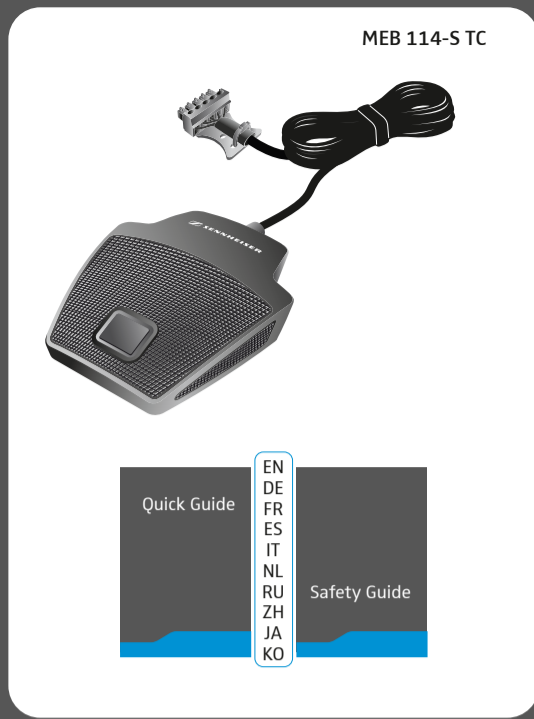

Downloading the system manual | Systemanleitung herunterladen | Télécharger le manuel système | Download della guida di sistema | Descargar las instrucciones del sistema | De systeemhandleiding downloaden | Загрузка руководства | 下载系统说明 | システムの取扱説明書のダウンロード | 시스템 설명서 다운로드

Connecting the components | Die Komponenten anschließen | Connecter les composants | Connettere i componenti | Conectar los componentes | De componenten aansluiten | Подключение блоков | 连接组件 | 製品の接続 | 구성품 연결



[www.sennheiser.com](http://www.sennheiser.com)  
TeamConnect Instruction Manual

Sennheiser electronic GmbH & Co. KG  
Am Labor 1, 30900 Wedemark, Germany  
[www.sennheiser.com](http://www.sennheiser.com)

Printed in Germany, 560033, Publ. 09/14, A02

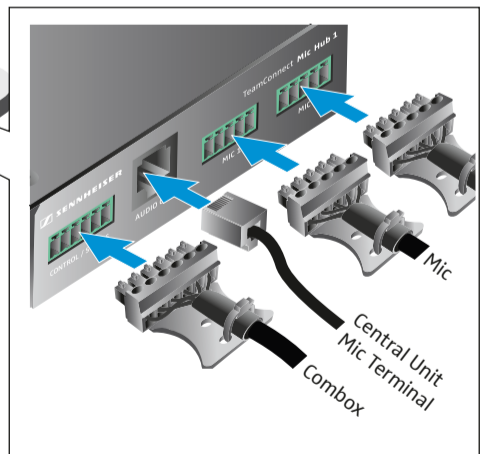
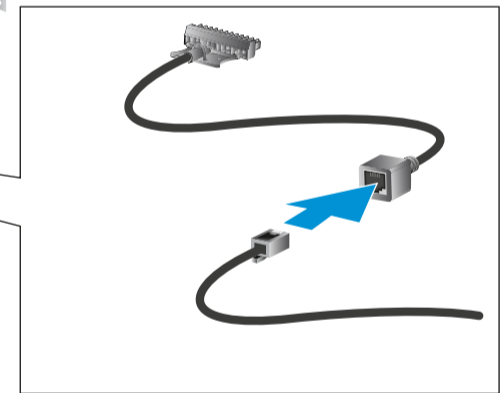
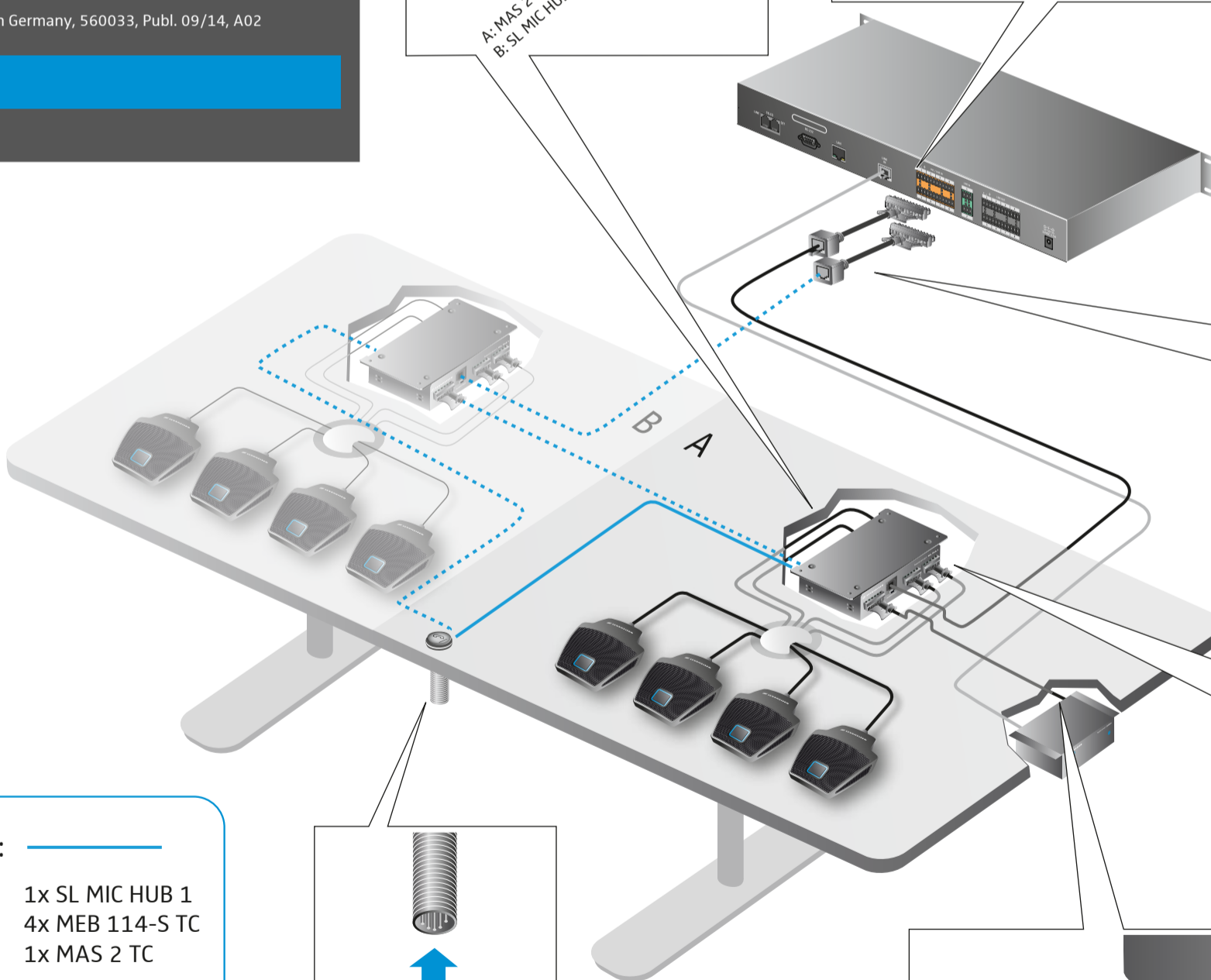
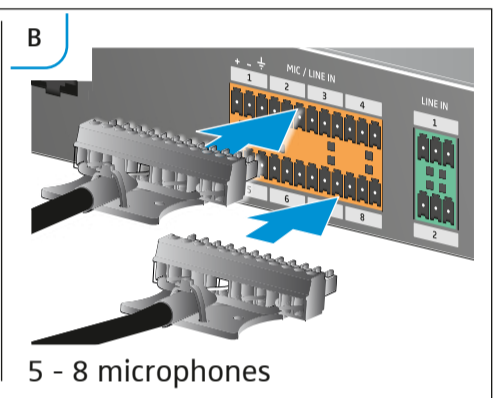
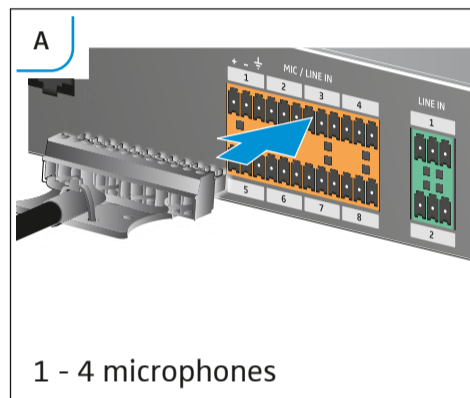
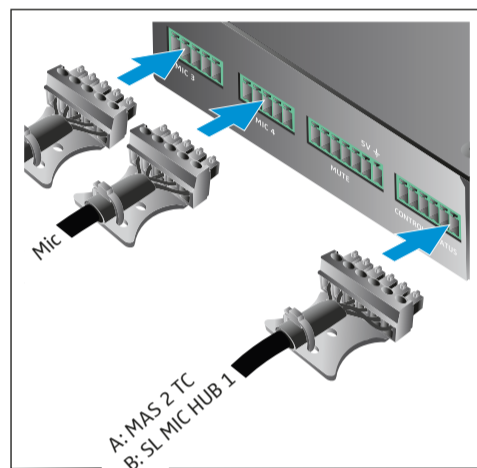

**A:** ————  
1x SL MIC HUB 1  
4x MEB 114-S TC  
1x MAS 2 TC

**B:** .....  
2x SL MIC HUB 1  
8x MEB 114-S TC  
1x MAS 2 TC

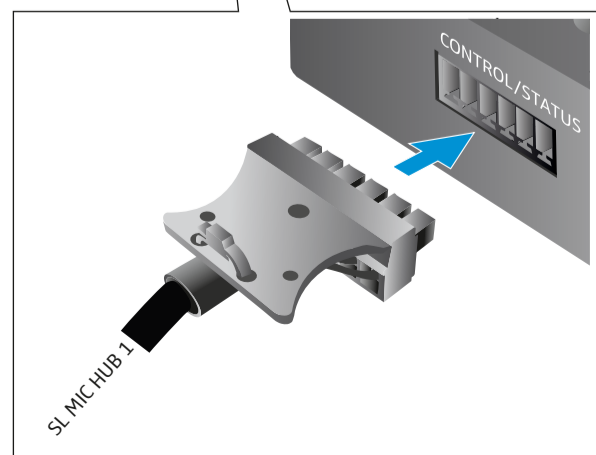
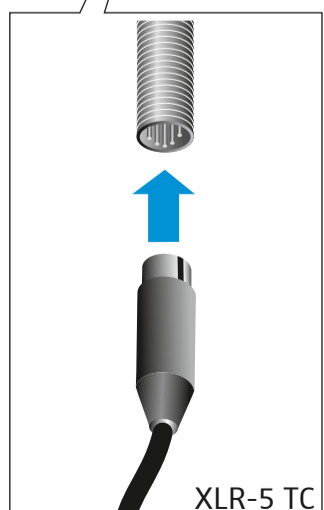

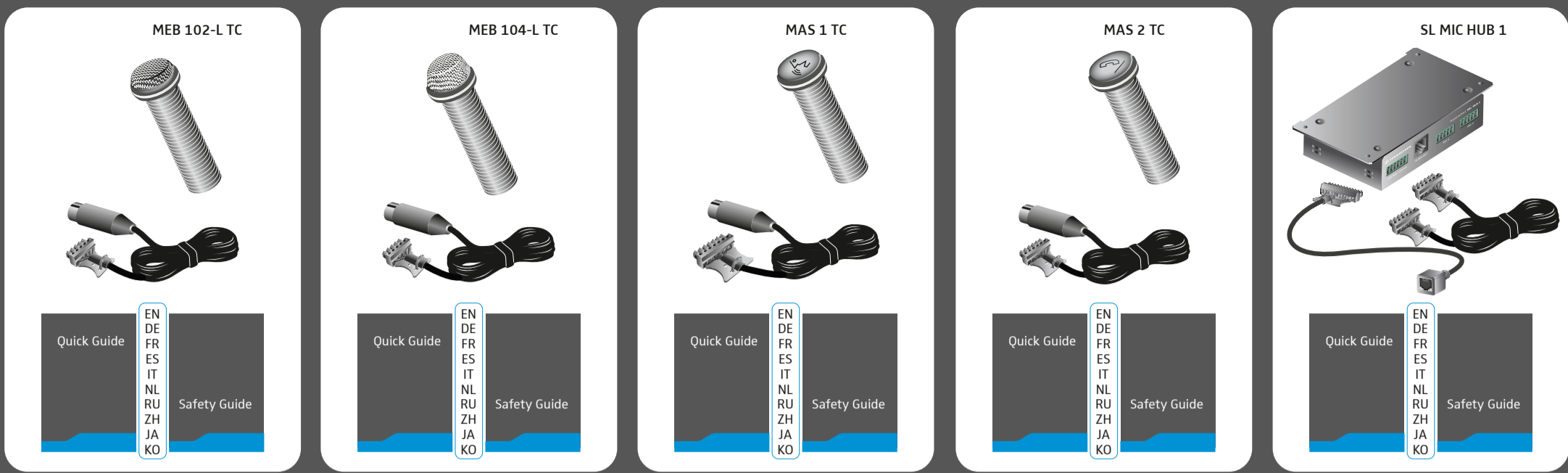

Connecting the components | Die Komponenten anschließen | Connecter les composants | Connettere i componenti | Conectar los componentes | Conectar los componentes | De componenten aansluiten | Подключение блоков | 连接组件 | 製品の接続 | 구성품 연결

- A:**
- 1x SL MIC HUB 1
  - 4x MEB 102-L / MEB 104-L
  - 1x MAS 1 TC
  - 1x MAS 2 TC

- B:**
- 2x SL MIC HUB 1
  - 8x MEB 102-L / MEB 104-L
  - 2x MAS 1 TC
  - 1x MAS 2 TC

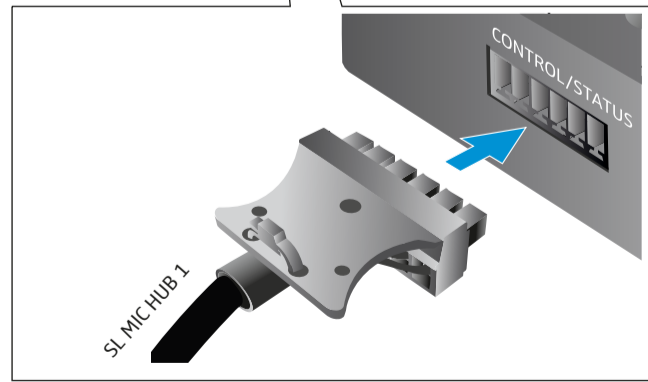
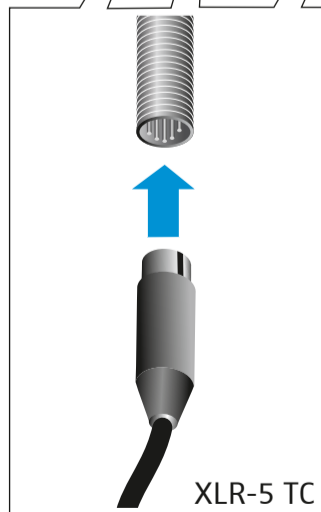
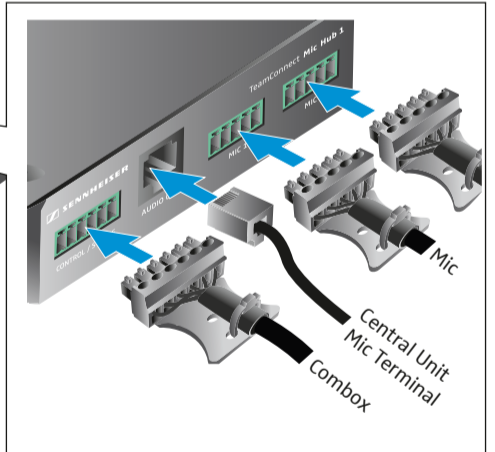
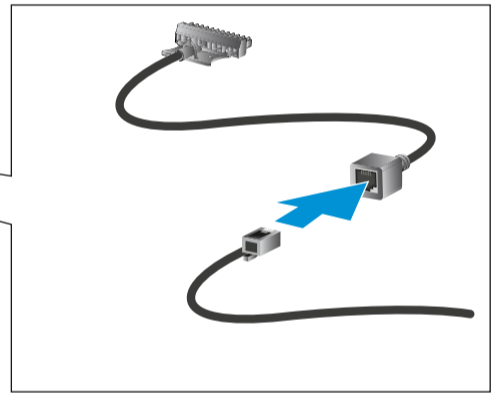
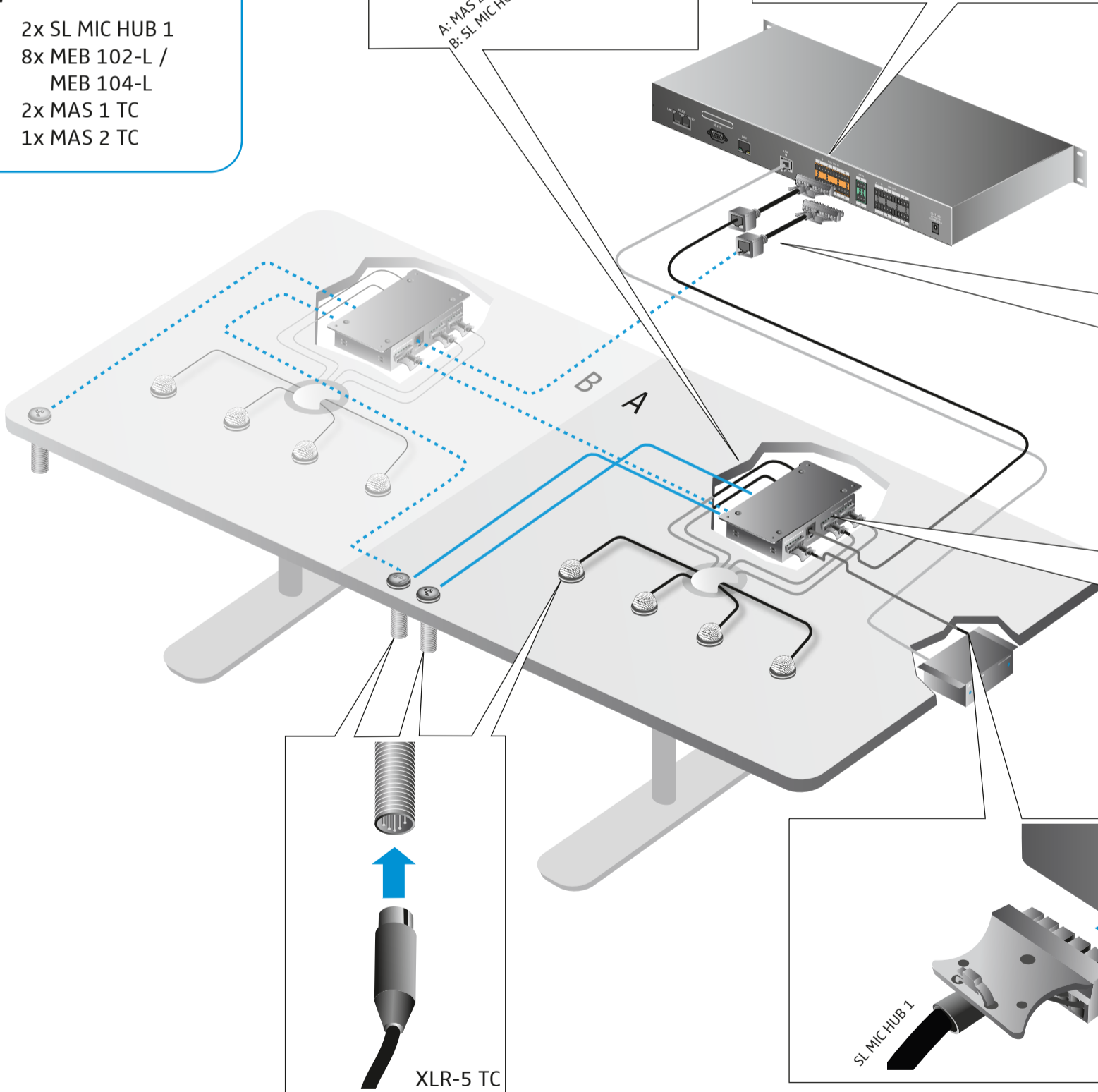
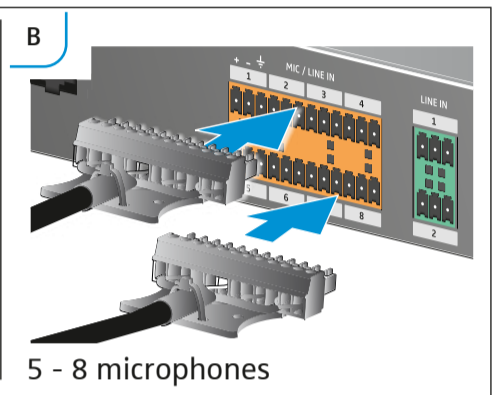
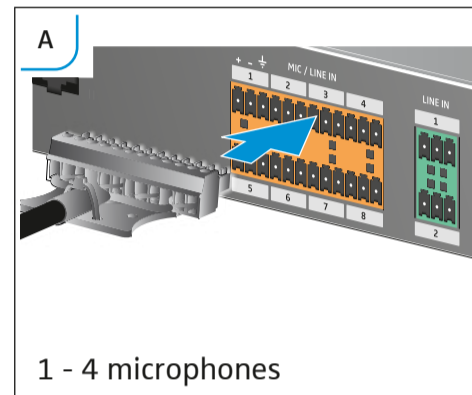
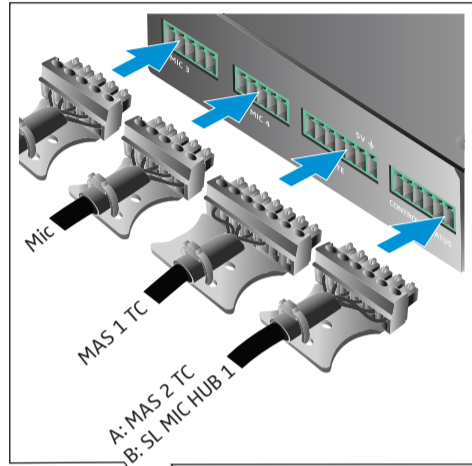

**SL MIC HUB 1**



**MIC 1 - MIC 4 sockets**

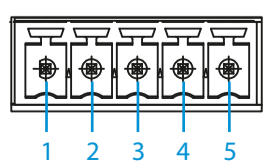

- 1 mute
- 2 mute status
- 3 ground
- 4 audio +
- 5 audio -

**CONTROL / STATUS sockets**

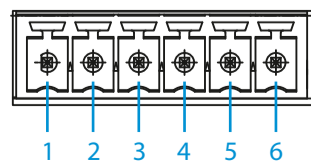

- 1 mute
- 2 mute status
- 3 hook
- 4 hook status
- 5 +5V
- 6 ground

**MUTE socket**

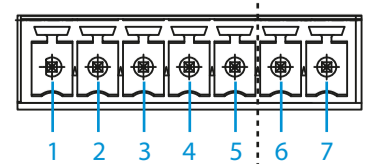

for external power supply

- 1 +5V out
- 2 mute
- 3 red
- 4 green
- 5 ground
- 6 +5V in
- 7 ground